

DAC

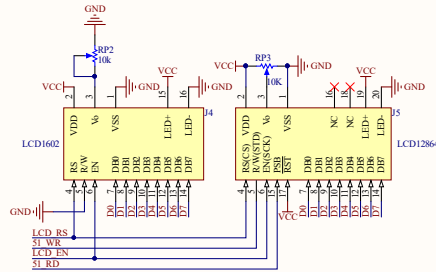

1602液晶&12864

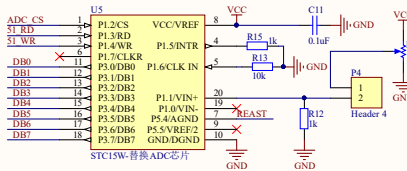

ADC

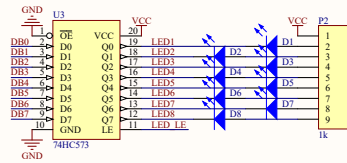

流水灯

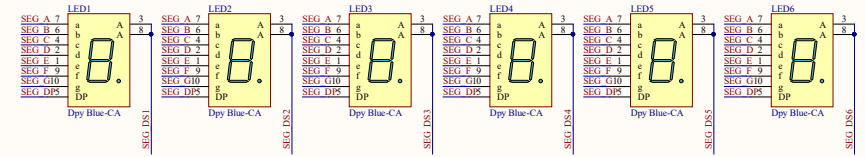

数码管

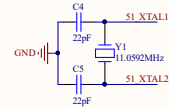
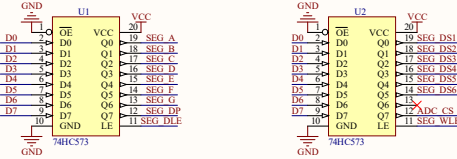

晶振电路

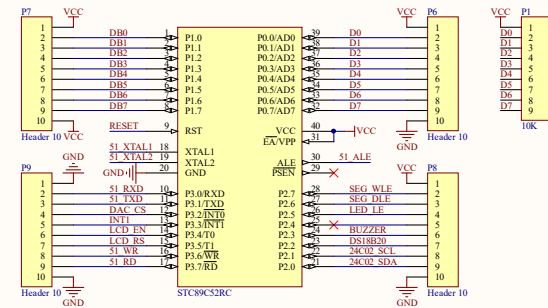

MCU 最小系统

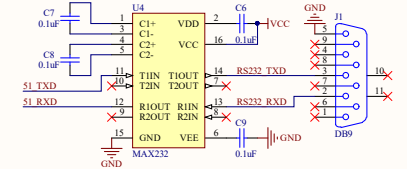

MAX232

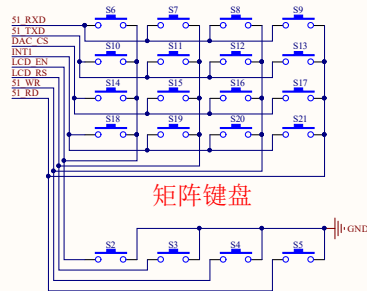

独立按键

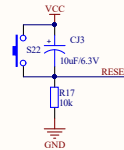

复位电路

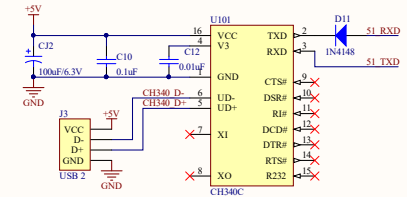

CH340C 下载

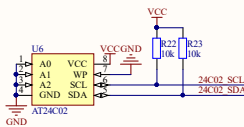

AT24C02

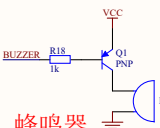

蜂鸣器

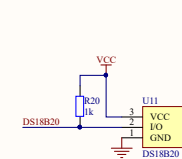

DS18B20

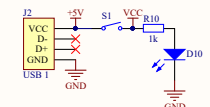

开关电路

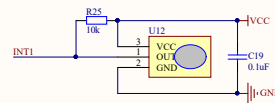

红外接收

Title		
Size	Number	Revision
C		
Date:	2024-08-07	Sheet of
File:	D:\jovon_zhuonian\TX-IV V6.0\Sch\B.dwg	By: